

Perspektywa
według
Strzemińskiego

kontur



kontur w konturze



kontynuacja



sylwetki

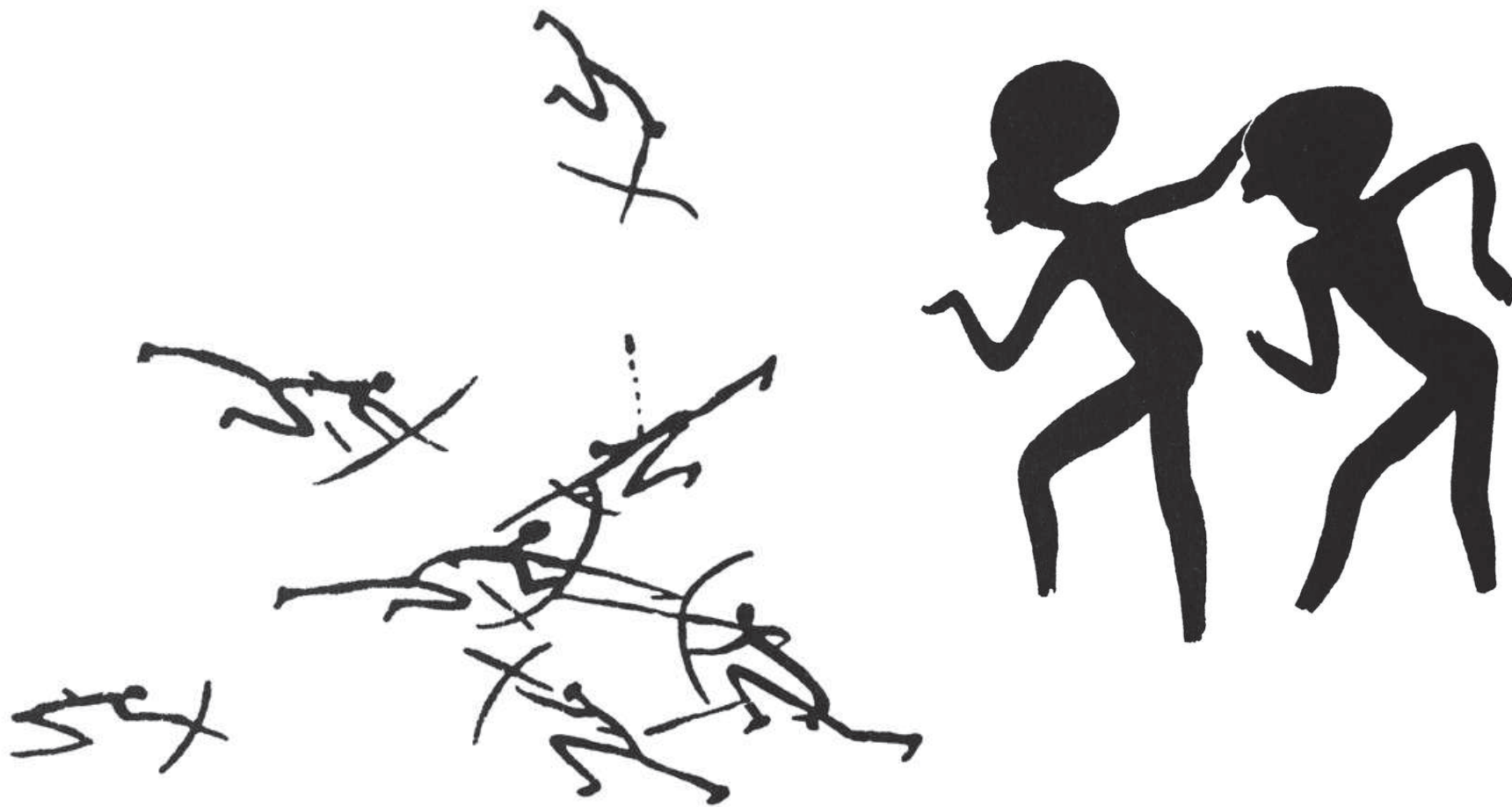

kontynuacja



intencjonalna



kontynuacja



wielorzędowa

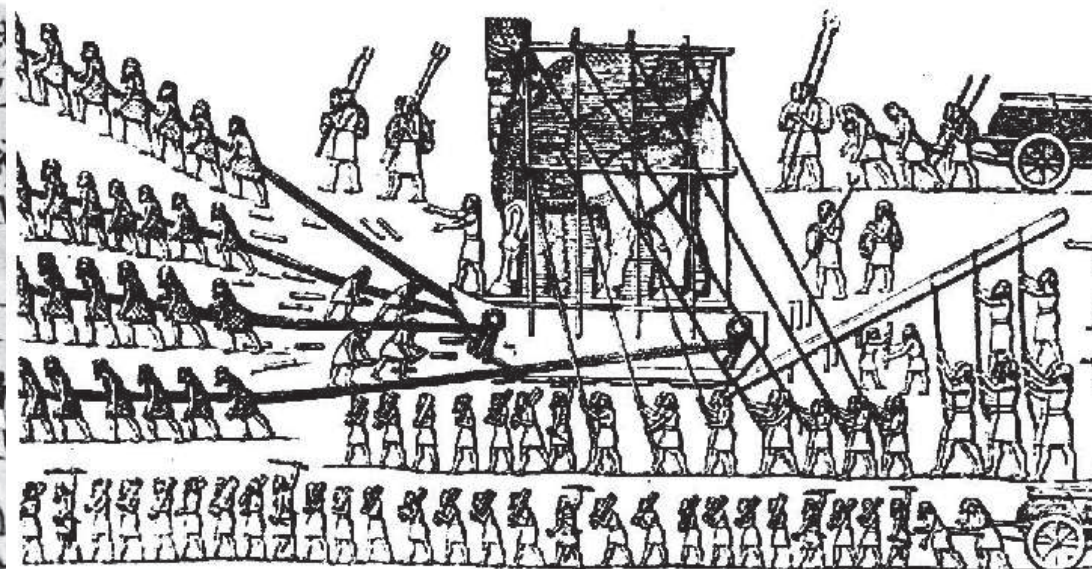
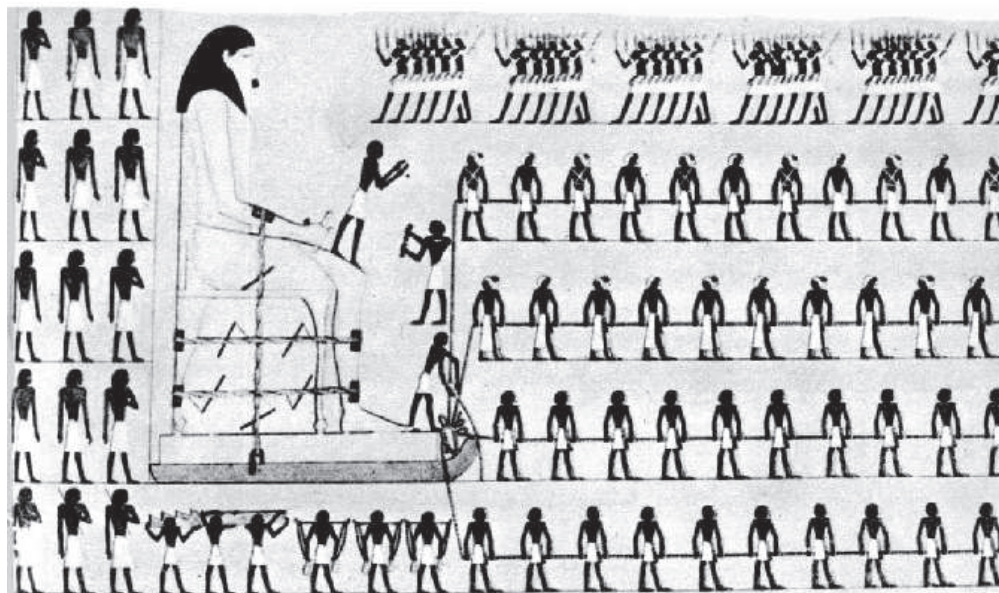

kontynuacja



rozzutowana

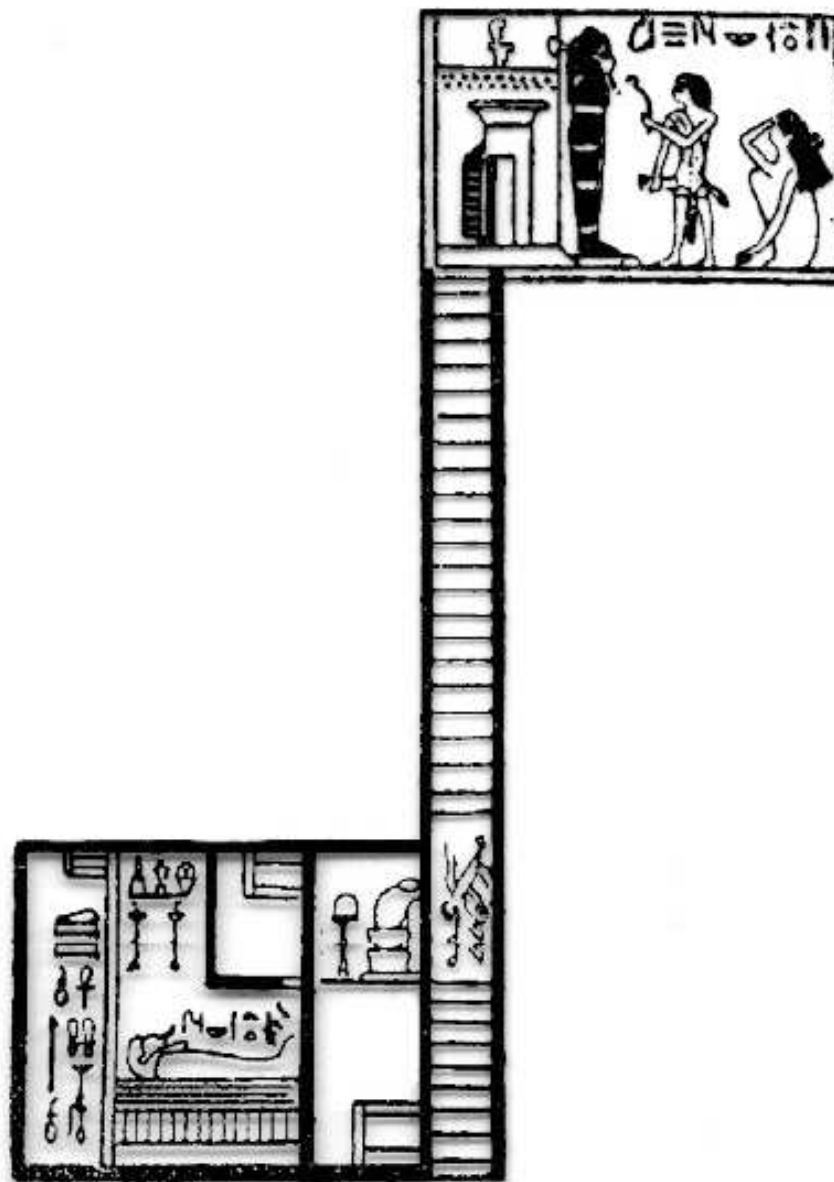
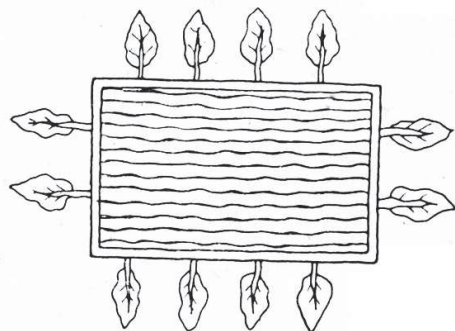
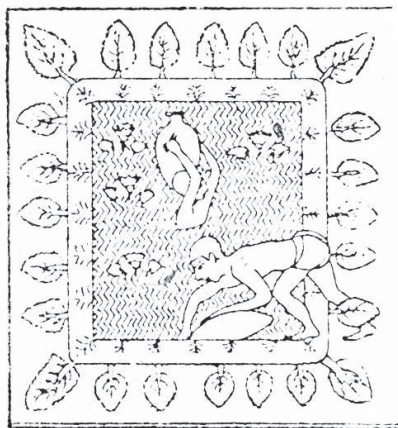

kontynuacja – geometria wykreślna

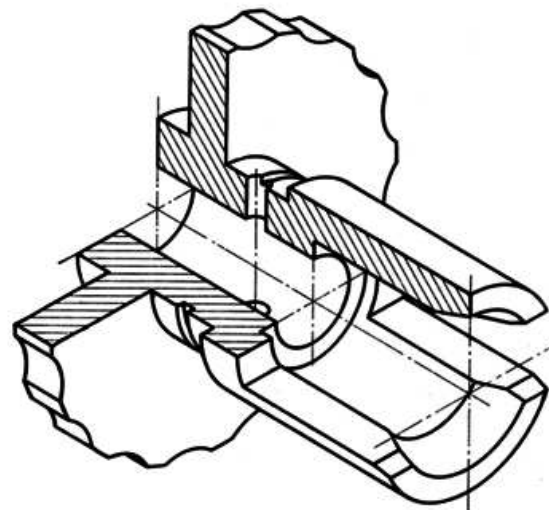
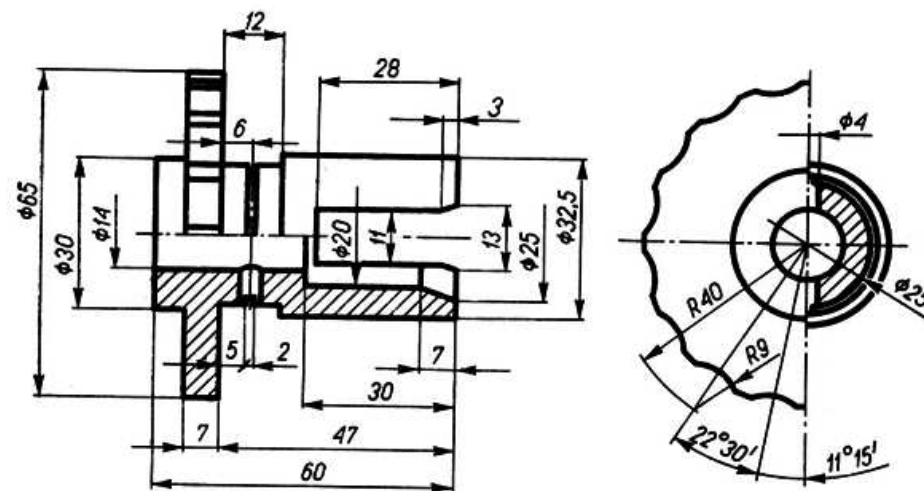

dorycka = szkolna

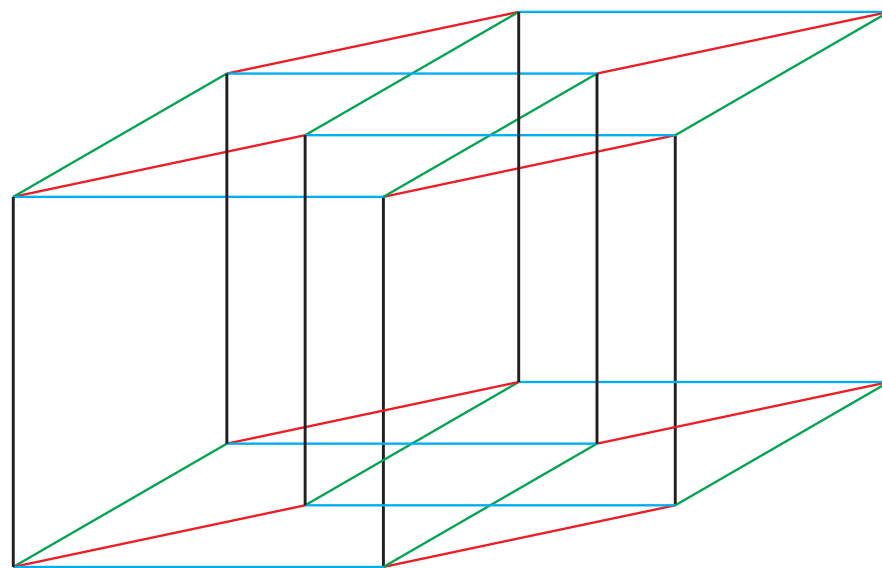
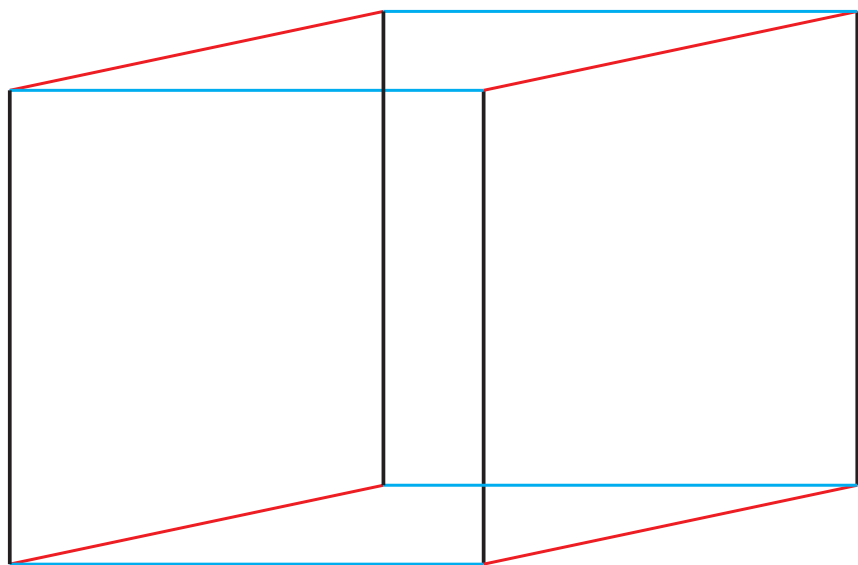

paradoksalność

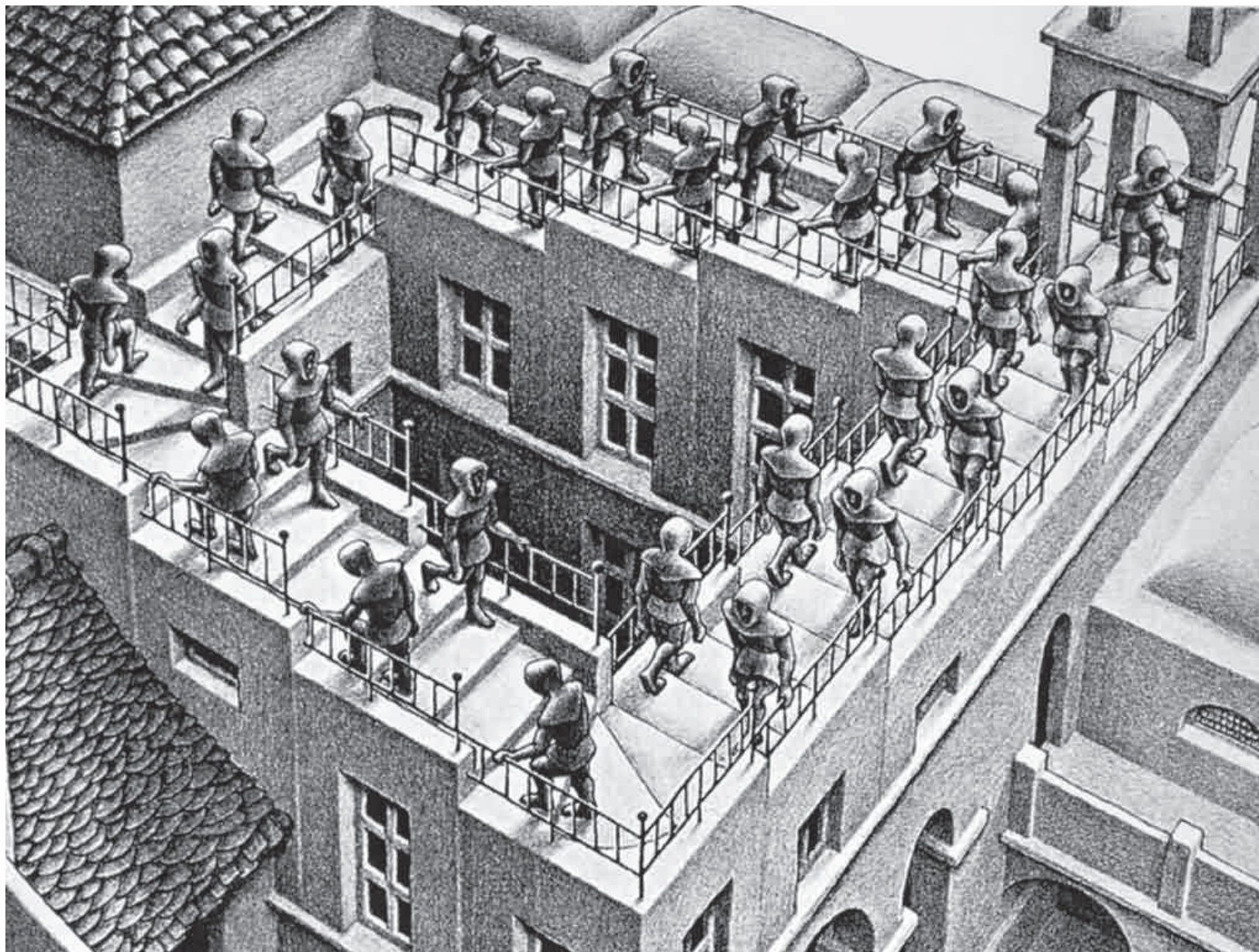

orientalne

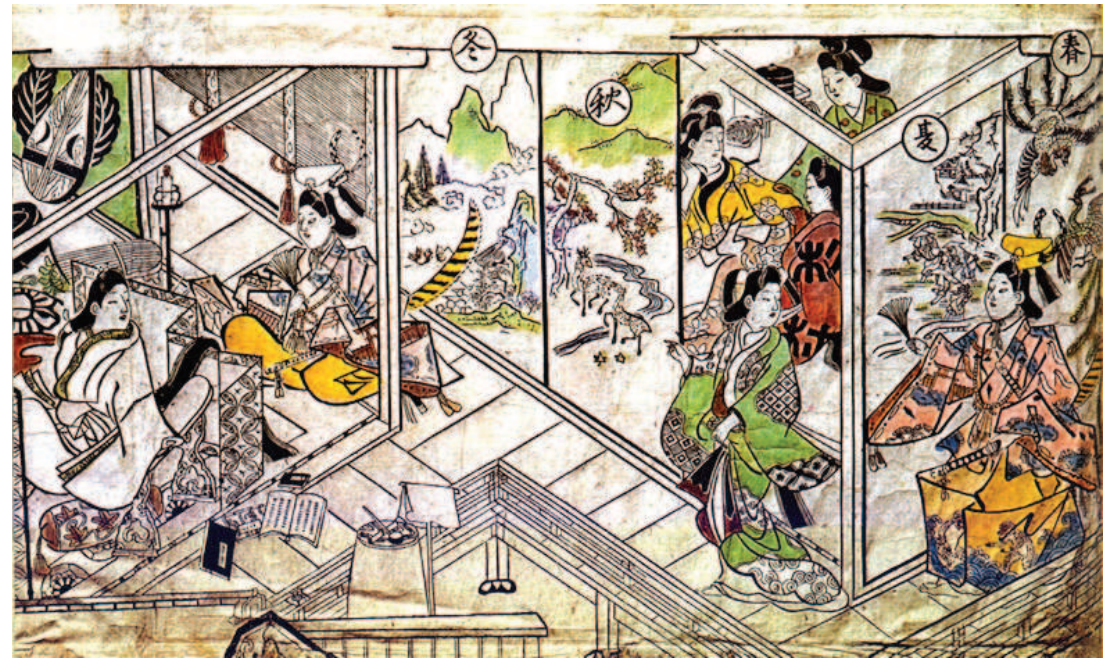

optyczna = zbieżna



optyczna = zbieżna

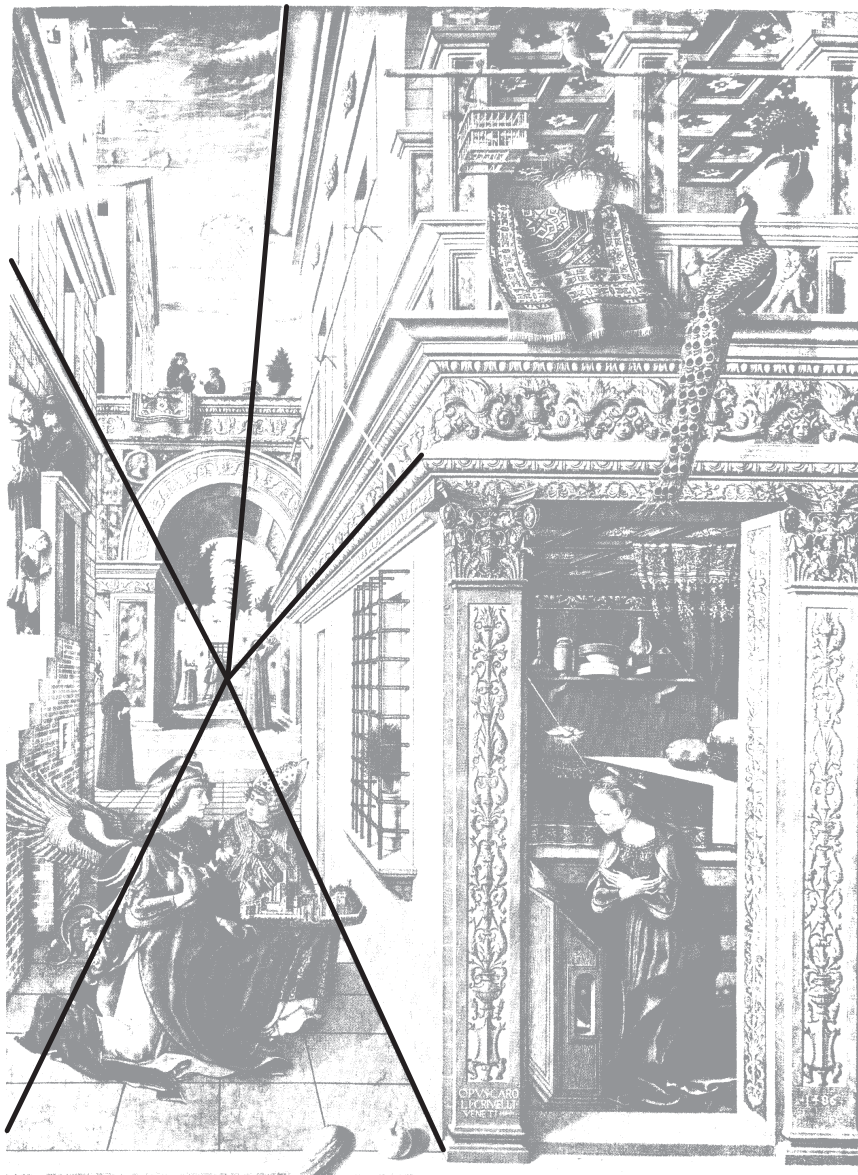

wspomaganie

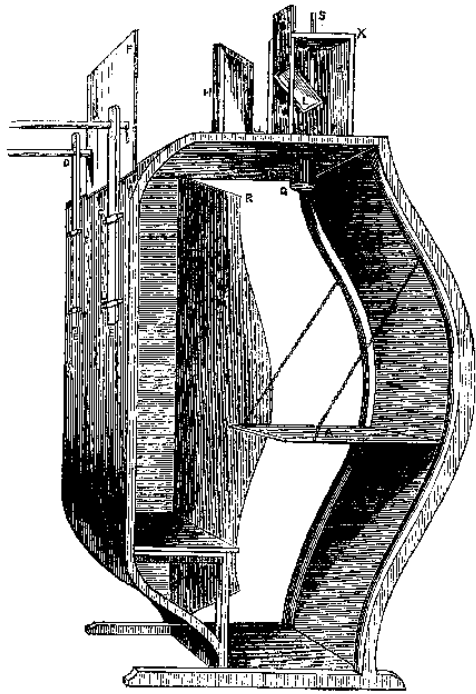
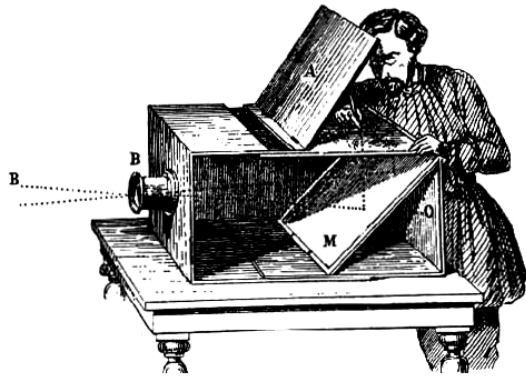

impresjonistyczna



kubizm



kubizm



dadaizm, surrealizm, pop-art, op-art...

